

FUZZY CONTROLLED IMPROVED ACTIVE POWER FILTER FOR POWER QUALITY IMPROVEMENT

KANUMURI SAILATHA¹, Mr.G.SRINIVAS²

Abstract

The widespread use of non-linear loads is leading to a variety of undesirable phenomena in the operation of power systems. The harmonic components in current and voltage waveforms are the most important among these. Conventionally, passive filters have been used to eliminate line current harmonics. However, they introduce resonance in the power system and tend to be bulky. So, active power line conditioners have become more popular than passive filters as it compensates the harmonics and reactive power simultaneously. An active power filter implemented with a four-leg voltage-source inverter using a predictive control scheme is presented. The use of a four-leg voltage-source inverter allows the compensation of current harmonic components, as well as unbalanced current generated by single-phase nonlinear loads. A detailed yet simple mathematical model of the active power filter, including the effect of the equivalent power system impedance, is derived and used to design the predictive control algorithm. The compensation performance of the proposed active power filter and the associated control scheme under steady state and transient operating condition is demonstrated through simulations and experimental results.

Keywords

passive filters, power system, harmonics and reactive power simultaneously.

¹ M.Tech Student, Dept. of EEE, Vignan Institute of Technology & science, Deshmukhi (V), Pochampally (M), Nalgonda-508 284.

² Assistant Professor, Dept. of EEE, Vignan Institute of Technology & science, Deshmukhi (V), Pochampally (M), Nalgonda-508 284.

Contents

1	INTRODUCTION	28
2	LITERATURE SURVEY	29
3	THEROTICAL ANALYSIS	29
4	Fuzzy Logic Technique	29
5	MATLAB SIMULATION & RESULTS	30
6	CONCLUSION	30
7	FUTURE SCOPE	31
	References	32

1. INTRODUCTION

The widespread use of non-linear loads is leading to a variety of undesirable phenomena in the operation of power systems. The harmonic components in current and voltage waveforms are the most important among these. Conventionally, passive filters have been used to eliminate line current harmonics. However, they introduce resonance in the power system and tend to be bulky. So, active power line conditioners have become more popular than passive filters as it compensates the harmonics and reactive power simultaneously. The active power filter topology can be connected in series or shunt and combinations of both. Shunt active filter is more popular than

series active filter because most of the industrial applications require current harmonic compensation. Different types of active filters have been proposed to increase the electric system quality. The classification is based on following criteria. 1. Power rating and speed of response required in compensated system. 2. System parameters to be compensated (e.g. current harmonics, power factor and voltage harmonics) 3. Technique used for estimating the reference current/voltage. One of the most common problems when connecting small renewable energy systems to the electric grid concerns the interface unit between the power sources and the grid, because it can inject harmonic components that may deteriorate the power quality.

The increasing use in the industry of non-linear loads based on the power electronic elements also introduced serious perturbation problems in the electric power distribution grids. Also, regular increase in the harmonic emissions and current unbalance in addition to high consumption of reactive power can be noticed. The flow of harmonic currents in the electric grids can also cause voltage harmonics and disturbance. These harmonic currents can interact adversely with a wide range of power system equipment's, control systems, protection circuits and other harmonic sensible loads. The energy distributors like consumers were concerned by imposing some regula-

tion protection against the expansion of harmonic problem.

2. LITERATURE SURVEY

J.Rocabert , A.Luna ,F.Blaabjerg ,and P.Rodriguez ,Control of power converters in AC micro grids,IEEE Trans. Power Electron.,vol.27,no.11,pp. 4734-4749,Nov,2012 This paper carries out an overview about micro grid structures and control techniques at different hierarchical levels. At the power converter level, a detailed analysis of the main operation modes and control structures for power converters belonging to micro grids is carried out, focusing mainly on grid-forming, grid-feeding, and grid-supporting configurations. This analysis is extended as well toward the hierarchical control scheme of micro grids, which, based on the primary, secondary, and tertiary control layer division, is devoted to minimize the operation cost, coordinating support services, meanwhile maximizing the reliability and the controllability of micro grids. Finally, the main grid services that micro grids can offer to the main network, as well as the future trends in the development of their operation and control for the next future, are presented and discussed. M. Aredes, J. Hafner, and K.Heumann, || Three-phase four-wire shunt active filter control strategies, || IEEE Trans.Power Electron.,vol. 12, no. 2,pp.311-318,May.1997. This paper describes a three-phase four-wire shunt active power filter using a conventional three-leg converter, without the need of power supply at dc bus. Two approaches have been developed to control the active filter. Both control strategies consider harmonics and zero sequence components in the voltage and current simultaneously. The first one provides constant power and the second one sinusoidal current to the source, even under VITS,Dept of EEE 14 unbalanced voltage conditions. Simulation results from a complete model of shunt active filter are presented to validate and compare the control strategies.

3. THEROTICAL ANALYSIS

Renewable generation affects power quality due to its non linearity, since solar generation plants and wind power generators must be connected to the grid through high-power static PWM converters . The non uniform nature of power generation directly affects voltage regulation and creates voltage distortion in power systems. This new scenario in power distribution systems will require more sophisticated compensation techniques. Although active power filters implemented with three-phase four-leg voltage-source inverters (4L-VSI) have already been presented in the technical literature , the primary contribution of this paper is a predictive control algorithm designed and implemented specifically for this application.

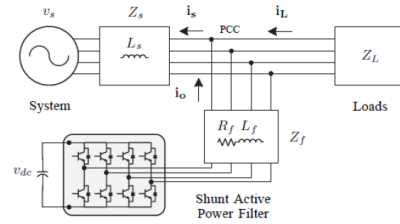

Figure 1. Schematic Diagram of Proposed Shunt Active Power Filter

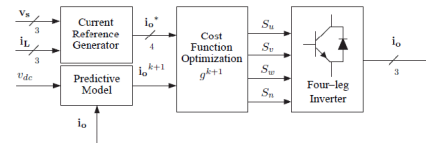

Figure 2. Proposed Predictive Digital Current Control Block Diagram

4. Fuzzy Logic Technique

In recent years, the number and variety of applications of fuzzy logic have increased significantly. The applications range from consumer products such as cameras, camcorders, washing machines, and microwave ovens to industrial process control, medical instrumentation, decision-support systems, and portfolio selection. Fuzzy logic has two different meanings. In a narrow sense, fuzzy logic is a logical system, which is an extension of multi-valve logic. However, in a wider sense fuzzy logic (FL) is almost synonymous with the theory of fuzzy sets, a theory which relates to classes of objects with un-sharp boundaries in which membership is a matter of degree. In this perspective, fuzzy logic in its narrow sense is a branch of fl. Even in its more narrow definition, fuzzy logic differs both in concept and substance from traditioSnal multi-valve logical systems. First-generation simple fuzzy logic controllers can generally be depicted by a block diagram. The knowledge-base module contains knowledge about all the input and output fuzzy partitions. It will include the term set and the corresponding membership functions defining the input variables to the fuzzy rule-base system and the output variables, or control actions, to the plant under control.

Fuzzy inference is a method that interprets the values in the input vector and, based on user defined rules, assigns

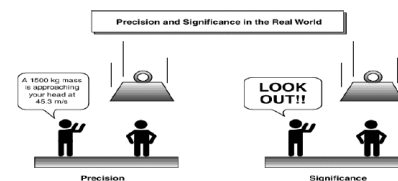

Figure 3. Fuzzy Description

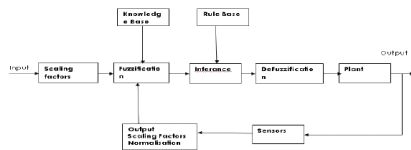

Figure 4. Simple Fuzzy Logic Control System

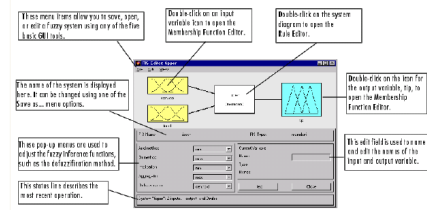

Figure 7. the FIS Editor

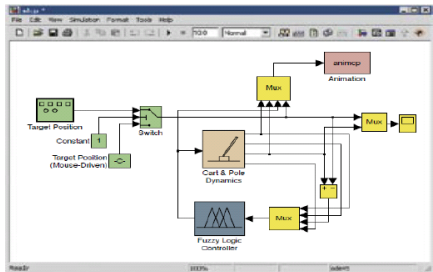

Figure 5. Fuzzy Inference System

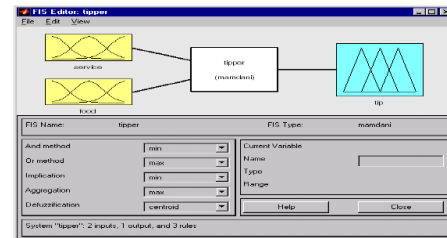

Figure 8. the Updated FIS Editor

values to the output vector. Using the GUI editors and viewers in the Fuzzy Logic Toolbox, you can build the rules set, define the membership functions, and analyse the behaviour of a fuzzy inference system (FIS). The following editors and viewers are provided.

The FIS Editor displays general information about a fuzzy inference system. There's a simple diagram as shown in Fig.. That shows the names of each input variable on the left, and those of each output variable on the right. The sample membership functions shown in the boxes are just icons and do not depict the actual shapes of the membership functions.

5. MATLAB SIMULATION & RESULTS

Renewable energy source (RES) integrated at distribution level is termed as distributed generation (DG). The utility is concerned due to the high penetration level of intermittent RES in distribution systems as it may pose a threat to network in terms of stability, voltage regulation and power-quality (PQ) issues. Therefore, the DG systems are required to comply with strict technical and

regulatory frameworks to ensure safe, reliable and efficient operation of overall network. With the advancement in power electronics and digital control technology, the DG systems can now be actively controlled to enhance the system operation with improved PQ at PCC. However, the extensive use of power electronics based equipment and non-linear loads at PCC generate harmonic currents, which may deteriorate the quality of power. A simulation model for the three-phase four-leg PWM converter with the parameters shown in Table 5.1 has been developed using MATLAB-SIMULINK.

The objective is to verify the current harmonic compensation effectiveness of the proposed control scheme under different operating conditions. A six pulse rectifier was used as a non-linear load. In the simulated results shown in Fig.9 , phase to neutral source voltage at t=0 to t=0.8. Fig.10 shows the source currents at t=0 to t=0.8.

6. CONCLUSION

In this thesis, a DC-coupled System has been studied, to improve the power quality at point of common coupling with 3-phase 4-wire distributed generation. It has been shown that the grid interfacing inverter can be effectively utilized for power conditioning without affecting its nor-

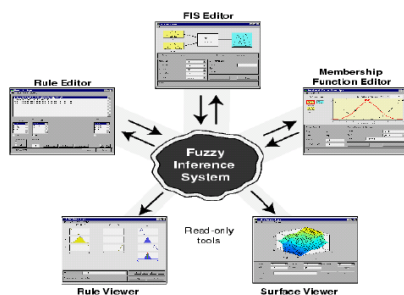

Figure 6. the Primary GUI Tools of the Fuzzy Logic Toolbox

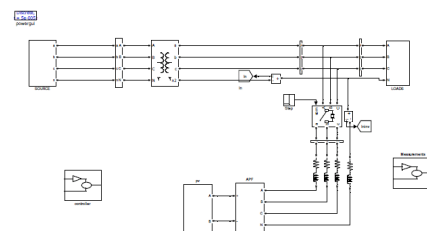

Figure 9. Main SIMULINK Circuit for the Grid Connected Solar Energy System with Shunt APF

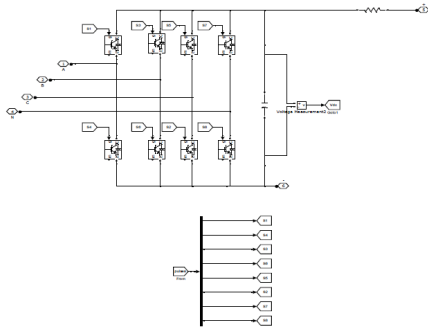

Figure 10. Four Leg Inverter

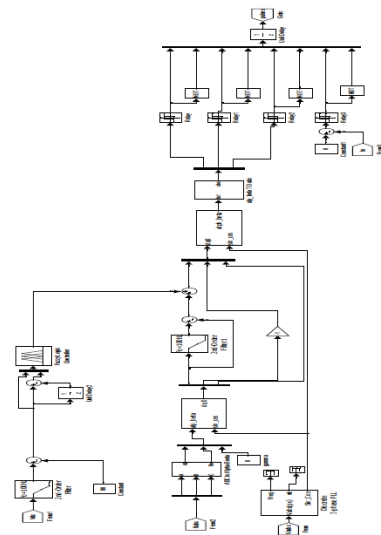

Figure 11. Control Circuit for Four Leg Inverter

Table 1. Specification parameters

Variable	Description	Value
V_s	Source voltage	55 [V]
F	System frequency	50 [Hz]
V_{dc}	dc-Voltage	162 [V]
C_{dc}	dc capacitor	2200 [μF]
L_f	Filter inductor	5.0 [mH]
R_f	Internal resistance	0.6 [Ω]
T_s	Sampling time	20 [μs]
T_e	Execution time	16 [μs]

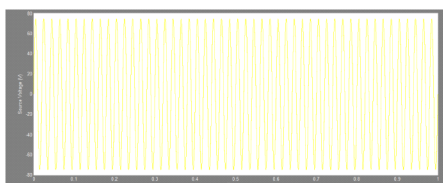

Figure 12. Phase to Neutral Source Voltage

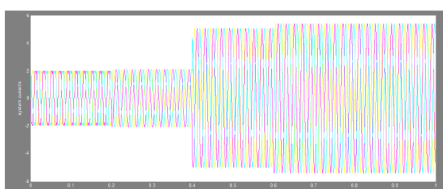

Figure 13. Source Currents

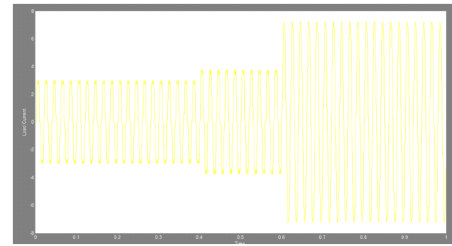

Figure 14. Load Current at $0 < t < 0.8$

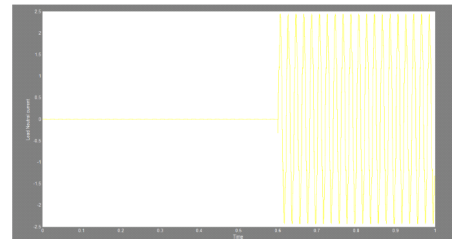

Figure 15. Load Neutral Current

mal operating of real power transfer. The grid-interfacing inverter with the proposed approach can be utilized to: i) Inject real power generated from RES to the grid, ii) Operate as a shunt Active Power Filter. This approach thus eliminates the need for additional power conditioning equipment to improve the quality of power at PCC. The MATLAB/SIMULINK 2009a simulation model of the proposed system with the connection of renewable energy sources is shown and validated. The control circuit is operated with phase lock loop, proportional integral controller and hysteresis controller which is used to generate the gating pulses for the 4-leg inverter and is carried out at load side with non-linear unbalanced load. Thus the current unbalance, current harmonics and load reactive power, due to unbalanced and non-linear load connected to the PCC, are compensated effectively such that the grid side currents are always maintained as balanced and sinusoidal at unity power factor.

7. FUTURE SCOPE

Fuzzy logic and neural network techniques are now being increasingly applied to power electronics. The integration of fuzzy logic with neural networks and genetic algorithms is now making automated cognitive systems a reality in

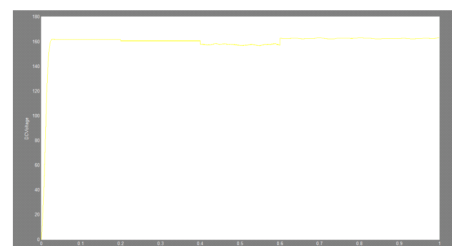

Figure 16. DC Voltage Converter

many disciplines. The power of fuzzy systems when integrated with learning capabilities of neural networks and genetic algorithms is responsible for new commercial products and processes that are effective cognitive systems. The performance of the above mentioned Hysteresis controller based Shunt active filter can be improved by fuzzy logic controller & also neural network techniques

References

- [1] J.Rocabert, A.Luna, F.Blaabjerg, and P.Rodriguez, "Control of power converters in AC micro-grids," *IEEE Trans. Power Electron.*, vol. 27, no. 11, pp. 4734-4749, Nov, 2012.
- [2] M. Aredes, J. Hafner, and K. Heumann, "Three-phase four-wire shunt active filter control strategies," *IEEE Trans. Power Electron.*, vol. 12, no. 2, pp. 311-318, May, 1997.
- [3] S. Ali, M. Kazmeierkowski, "PWM voltage and current control of four-leg VSI," presented at the ISIE, Pretoria, South Africa, vol. 1, pp. 196-201, Jul, 1998.
- [4] X. Wei, "Study on digital pi control of current loop in active power filter," in *Proc. 2010 Int. Conf. Electr. Control Eng.*, Jun. 2010, pp. 4287-4290.
- [5] S. Kouro, P. Cortes, R. Vargas, U. Ammann, and P. Rodriguez, "Model predictive control—A simple and powerful method to control power converters," *IEEE Trans. Ind. Electron.*, vol. 56, no. 6, pp. 1826-1838, Jun. 2009.

Author Profile

KANUMURI SAILATHA



M.Tech Student, Dept. of EEE, Vignan Institute of Technology & science, Deshmukhi (V), Pochampally (M), Nalgonda-508 284.

Mr.G.SRINIVAS

Assistant Professor, Dept. of EEE, Vignan Institute of Technology & science, Deshmukhi (V), Pochampally (M), Nalgonda-508 284.

Copyright@IJGSE
