

Current Trends in Ultra Capacitor/Battery Based Smart Transportation System

Geetha Reddy Evuri^{*1}, Research Scholar, Dept.of EEE, Vignan University, Vadlamudi, Guntur, A.P. gre.413@gmail.com

Dr. G.Srinivasa Rao², Professor, Dept. of EEE, Vignan University, Vadlamudi, Guntur, A.P,srn.gorantla@gmail.com

Dr.T.Ramasubba Reddy³, Professor, Dept. of EEE, VITAE, Deshmukhi, Hyderabad, T.S, India,

Dr.K.SrinivasaReddy⁴,Associate Professor, Dept. of ECE, NITS, Hyderabad, TS, India.

Abstract- This paper gives overall view of the current trends in ultra capacitor based smart transportation system. By increasing of the demand and popularity of EVs, there is huge demand of EVs to require shorten duration for the charging, so ultra capacitor(UC)/ battery hybrid energy storage for smart transportation system was proposed to enhance the life cycle of the battery and driving range. In this one more constraint is improving the regenerative braking energy and also satisfies the energy requirements of the system both in steady and dynamic state.

Keywords: ultra capacitor, battery, regenerative braking, energy management, EVs, EM System

1. Introduction

To reduce emissions, electric powered vehicles are in use in many cities. Although these mass transit vehicles enable large reductions in terms of emissions, their energy efficiency could be significantly improved. Furthermore, in city driving, had many conditions like low speeds, sufficient acceleration and sudden braking occur, implies that the public transportation sector is an ideal candidate to benefit from an enhanced ESS. Ultra capacitors form an ideal option for this purpose. They can accept high power peaks from regenerative braking, have a long life time, whenever the brakes are applied ,automatically the system decelerate which in turn convert the motor as a generator and supply hi amount of energy back to the system. It is used to charge the ultra capacitor where as the conventional battery failed to respond for such short duration pulses .During start up, hi amount of energy is required, which can be supplied by using ultra capacitor[1,15].

2. Ultra Capacitor

The Ultra capacitors (SCs), also called super capacitors or electrochemical capacitors, compare with conventional capacitors it utilize high surface area electrode material and thin electrolytic dielectrics to achieve capacitances of several orders of magnitude is very high. The SCs are also able to attain greater energy density while still maintaining high power density for a long period of time with negligible deterioration, that have been earlierly proposed in small applications consumer electronics as a memory back-up, micro solar power generators and now are proposed for high power/energy applications, such as hybrid and electric vehicles, power quality systems and smart grids. The advancements in new materials and the rapid growth of more demanding storage systems in a variety of applications have created a lack of universally accepted definitions of these devices and, consequently, a real difficulty in describing developments and progress in the SC field.

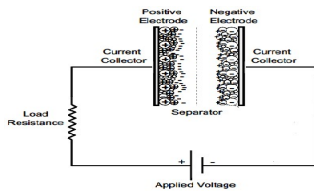

Figure 1.Schematic diagram of Ultra Capacitor

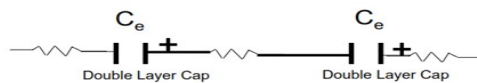

Figure 2. A model of Ultra Capacitor

**Corresponding Author: Geetha Reddy Evuri, Email : gre.413@gmail.com*

A) Battery

NiMH battery also called as a nickel metal hybrid battery, this is one type of rechargeable battery. The chemical reaction at the positive electrode is similar to that of the nickel – cadmium cell (NiCd), with both using nickel oxide hydroxide (NiOOH), the negative electrodes use a hydrogen absorbing alloy instead of cadmium[3,8]. A NiMH battery energy density can approach that of a lithium ion battery and has a higher energy density compared to the NiCd at the expense of reduced cycle life. No toxic metals contain by NiMH battery and used in mobile phones and laptop computers. Nickel hydrogen batteries are mainly used for satellite applications.

NiMH battery has hi energy density and uses environmentally friendly metals the energy density is more than 40% when compared to NiCd battery.

In present market NiCd replace with NIMH in the areas of wireless and mobile computing. NiCd durable compared with NiMH, but it has very higher capacity over a standard NiCd.

B) Advantages

The density levels of NiMH is more Compared with NiCd.Environmentaly friendly in term of lesser toxins. These are used in simple and public transportation systems but not for regulatory control.

The main drawbacks associated are limited service life, the performance deteriorates after 200-300 cycles .discharge current limited .reduces the battery life cycle due to repeated hi discharge current. Generate more heat while charging. Charging time required longer, hi maintenance these are designed to draw hi current, and more expensive .Recycling is profitable due to Nickel content, 35-45 % more capacity compared with NiCd. Very fast charging compared with NiCd, due to this reason use the smart chargers for avoid over charging otherwise it may damages the battery cells.NiMH battery technology is less expensive compared with other battery technologies. while Discharge to prevent crystalline formation. NiMH batteries designed for high current draw are more expensive than the regular version.

Parameters	Ultracapacitor	Battery-NiMH
Nominal capacity	58 F	-----
Voltage	15V	1.2v
Specific Energy (Wh/Kg)	5	44
Energy Specific cost (\$/wh)	16 (3000F cell at module level)	0.65
Maximum peak current	80A	0.8A
Power specific cost(\$/kw)	12	75
Weight	560 g	160g

TABLE 1. Comparisons of the ultra-capacitor vs NiMH Battery

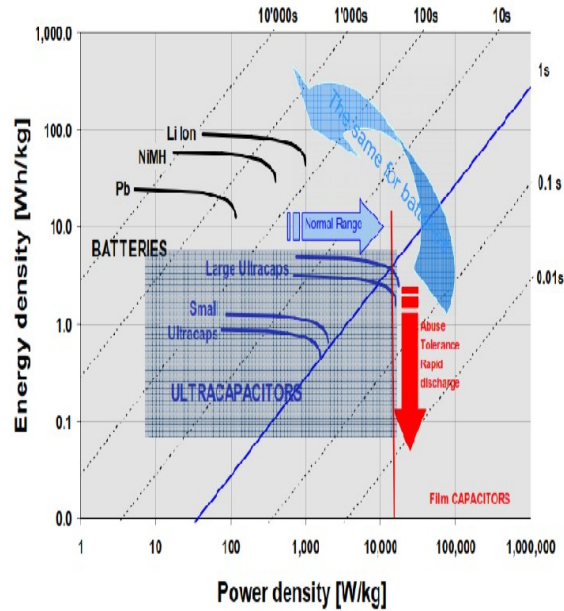

Figure 3. Representation of operating range of ultra capacitor vs batteries.

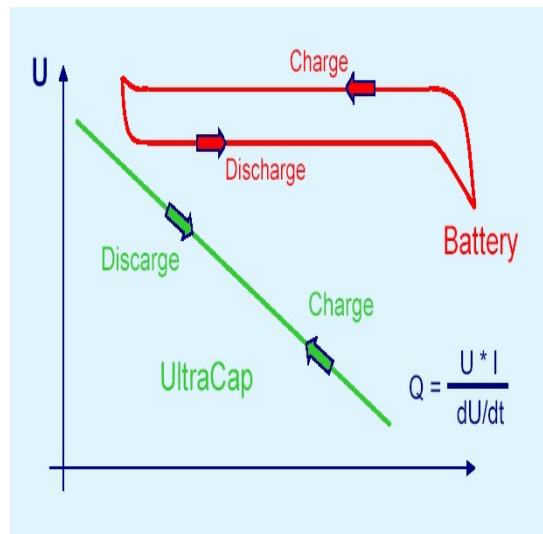

Figure 4. Representation of charge and discharge of ultra capacitor vs battery.

3. Current Trends In Ultra Capacitor (Ucaps)

Ucaps currently using in the areas of electric fork lift, where the battery packs are failed to supply to energy during transit period. The performance of the battery decrease with decreasing temperature. in harbor cranes construction, mining market require the charestics of deep discharge cycle coupled with hi duty cycle this can be achieved by using ultracapacitors. Many of the manufacturing company are provide the different types of ultra capacitors which are used as a backup battery packs/banks.where as conventional battery pack have some limitations based on the how much stress on battery[6,8] . in normal battery storage degrades while temperature decreasing .by searching alternative solution is by using ultra capacitors such applications nearly 20-30 % of fuel consumption reduced.

Current Trends In Ultra Capacitor/Battery Based Smart Transportation System

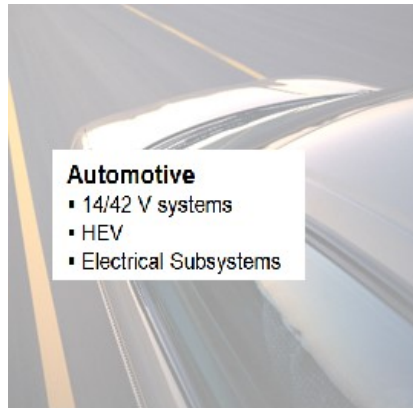

Figure 5. Representing UC application in automotives

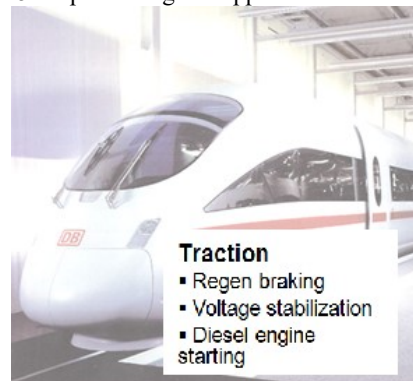

Figure 6. Representing UC application in trains



Figure 7. UC application in consumer electronics.

4. Smart Transportation System

In public transport system where Carbon emissions are more and the depletion's natural resources, which raises the cost of fossil fuels make the world to search for alternative means of transportation. Mass transit buses use hybrid electric propulsion system which can reduce emission upto 75%. Hybrid-electric vehicles (HEV) are powered by an electric motor which is smaller than a conventional internal combustion engine that operates at periods of maximum efficiency. This type of hybrid system developed with a regenerative braking system. By using this system to improves the duty cycle. It consists of ultra capacitors that stores kinetic energy that braking system and used later in the propulsion system. Ultracapacitor also employs start-stop systems, other high power functions[11,14].

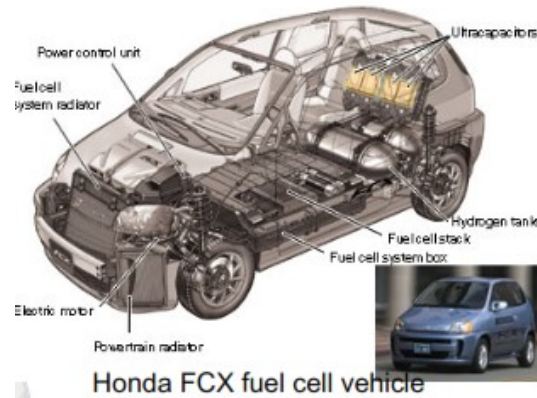

Figure 8. Representing the recently launched hybrid car with UC

5. Block Diagram Of Proposed System

- A. Batteries or Rechargeable cells: These batteries are electrically charged, while discharging to their original condition bypassing current through them in the opposite direction to that of the discharge current. The electric energy stored by storage devices are known as storage battery banks. These storage battery banks are charged by the charger which includes the simple ac to dc converter circuit.
- B. Bi- DC/DC Converter: in this bi-directional converter buck-boost DC/DC converter operates in buck mode when transferring power from DC bus to Ultra Capacitor, and vice-versa for boost mode.

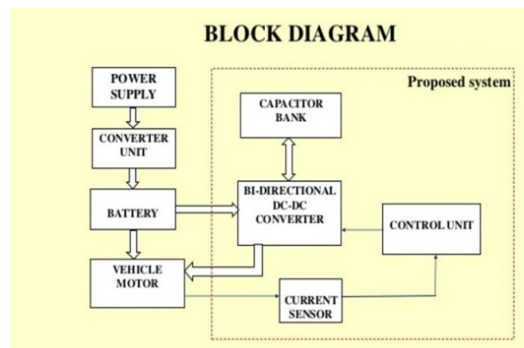

Figure 9. Proposed block diagram

- C. Ultra capacitor Bank: The ultra capacitor is a capacitor with large capacitance and high efficiency. It leads to the idea of using ultra capacitors as an alternative source to batteries. It is capable of very fast charges and discharges, a millions of cycles without degradation.

6. Conclusion

This paper gives an overview of modeling, advantages, disadvantages and various characteristics of ultra capacitor in the EM System. This paper also explains some limitations and problems of ultra capacitor in some transportation applications are reviewed. The future scope of the work is do further research on the modeling of the battery pack/banks, for considering the chemical process and chemical behaviors of an equivalent circuit model to achieve more precision model of the battery packs/banks.

*Corresponding Author: Geetha Reddy Evuri, Email : gre.413@gmail.com

References

- [1] Supercapacitors: Materials, Systems, and Applications, edited by F. Beguin and E. Frackowiak, published by Wiley-VCH, 2013
- [2] Technologies and Materials for Large Supercapacitors, edited by A. Nishino and K. Naoi, published by CMC International, 2010
- [3] Linden's Handbook of Batteries (Fourth Edition), edited by T.B. Reddy, Chapter 39: Electrochemical Capacitors by A.F. Burke, published by McGraw-Hill, 2011
- [4] Burke, A.F., Ultracapacitor technologies and applications in hybrid and electric vehicles, international journal of energy and research (Wiley), Vol. 34, issue 2, 2011
- [5] Electrochemical Double Layer Capacitors of Low Internal Resistance, Energy and Environmental Research, Vol. 3, No. 2, 156-165, 2013.
- [6] Burke, A.F., Advanced Batteries for Vehicle Applications, article in Encyclopedia of Automotive Engineering, Wiley, published online December 2012
- [7] Maletin, Y., et al., Carbon Based Electrochemical Double Layer Capacitors of Low Internal Resistance, Energy and Environmental Research, Vol. 3, No. 2, 156-165, 2013
- [8] Burke, A. and Miller, M., Lithium batteries and ultracapacitors alone and in combination in hybrid vehicles: Fuel economy and battery stress reduction advantages, paper presented at the Electric Vehicle Symposium 25, Shenzhen, China, November 2010
- [9] Zhao, H. and Burke, A.F., Fuel Cell Powered Vehicles using Ultracapacitors, Fuel Cells, Vol. 10, Issue 5, September 2010.
- [10] B. Lequesne, "Automotive Electrification: The Nonhybrid Story", Transportation Electrification, IEEE Transactions on, vol. 1, no. 1, June 2015.
- [11] J. Cao and A. Emadi, "A new battery/ultracapacitor hybrid energy storage system for electric, hybrid, and plug-in hybrid electric vehicles," Power Electron. IEEE Trans. On, vol. 27, no. 1, pp. 122–132, 2012.
- [12] F. Burke, "Batteries and Ultracapacitors for Electric, Hybrid, and Fuel Cell Vehicles," Proc. IEEE, vol. 95, no. 4, pp. 806–820, Apr. 2007.
- [13] M. H. Chabchoub and H. Trabelsi, "Consolidation of the electric vehicle battery by an ultracapacitor for performance improvement," in Systems, Signals & Devices (SSD), 2013 10th International Multi-Conference on, 2013, pp. 1–5.
- [14] S. M. Lukic, Jian Cao, R. C. Bansal, F. Rodriguez, and A. Emadi, "Energy Storage Systems for Automotive Applications," IEEE Trans. Ind. Electron., vol. 55, no. 6, pp. 2258–2267, Jun. 2008.
- [15] L. Gao, R. A. Dougal, and S. Liu, "Power enhancement of an actively controlled battery/ultracapacitor hybrid," *IEEE Transactions on Power Electronics*, vol. 20, no. 1, pp. 236–243, January 2005.